

REAR MOUNT UNDERBENCH

FUR-48 / FUF-48

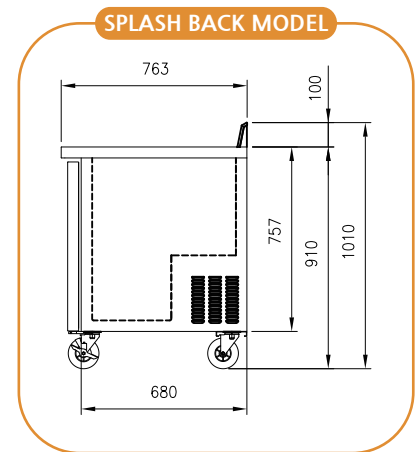
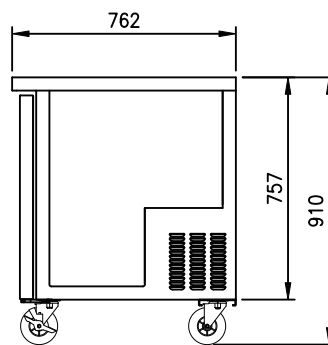
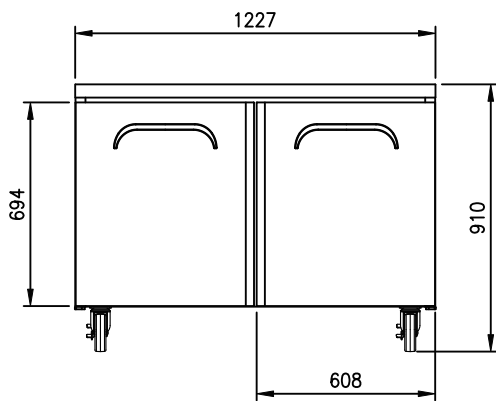
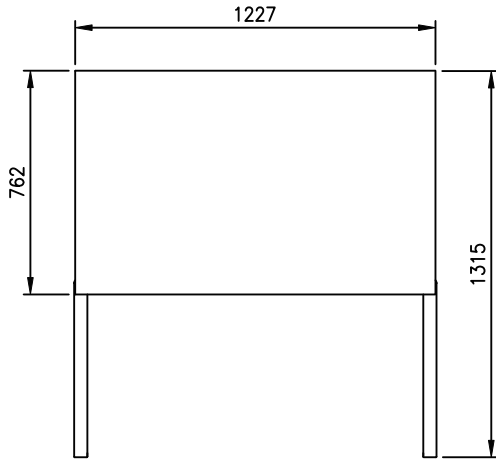

FEATURES

- Auto-closing doors & stopper
- Magnetic door gasket
- Locking dividers
- Stainless steel hood lid covers
- Stainless steel finished top, front, sides and doors
- PE coated sturdy wire shelves
- Rear-mount compressor for enhanced air flow
- 5" casters (brakes at front)
- Accommodates 15cm deep pan
- * Food pans are NOT included

TEMPERATURE

- Fridge: 0°C ~ 5°C
- Freezer: -18°C

OPTIONAL MODELS

- Drawer model
- 3" or 4" casters
- Splash back model (worktop)

Model	Capacity (l)	Exterior Dimension (mm)				Net Weight (kg)	Gross Weight (kg)	PowerSupply	Amps	Voltage (V/Hz/Ø)	Watt	HP	Refrigerant	No. Shelves	No. Door / Drawer
		W	D	H	H**										
FUR-48	346	1,227	762	910	1,010	95	103	10A	2.0	220/50,60/1	340	1/5	R-134a	2	2
FUF-48	346	1,227	762	910	1,010	100	108	10A	3.8	240/50/1	800(D:550)	1/2	R-404A	2	2

* Exterior height includes 5" for caster height.
 * Design and specifications subject to change without notice.
 * Actual shipping weight may differ due to extra packing materials for product protection.
 ** H: Splash back model