

WARMER

HOT FOOD DISPLAY

FMW-08GC

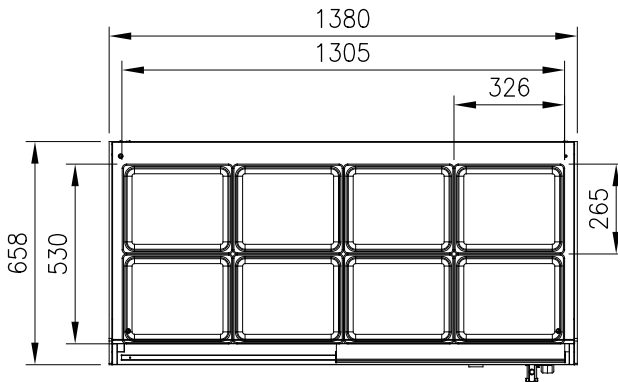
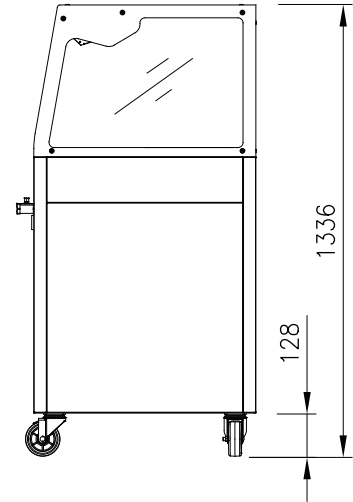
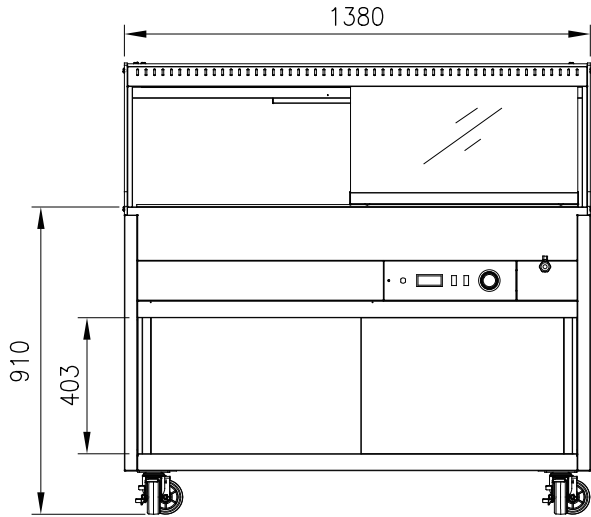

FEATURES

- Equipped half size 65mm deep pan
- Design to max 100mm deep (80mm is recommendable)
- Durable and stationary stainless steel finished
- Clear and attractive tempered front and side glasses
- Self stand model with spacious bottom storage
- Stylish heat lamps made with durable stainless designed to breathe

⚠ The heater must be completely submerged in case of wet use

- Dry or Wet operation
 - Wet: required to fill water until Wet heater submerged completely
 - Dry: Turn on the Heat Lamp on
- Digital Temp Display
- Safety lock ball valve drain

TEMPERATURE

- 40°C to 70°C

OPTIONAL MODELS

- Leg

Model	Exterior Dimension (mm)			Net Weight (kg)	Gross Weight (kg)	Wattage			Amps	Voltage (V/Hz/Ø)	No. Doors (Glass)	No. Pans (1/2")
	W	D	H			Heat Lamp	Wet heater	Total				
FMW-08GC	1,380	658	1,336	100	112	440	2640	3080	14	220~230/50,60/1	2	8

Exterior dimensions include 3" Leg height